



Item:

# SNEEZEGUARDS

Project Name: \_\_\_\_\_

Qty: \_\_\_\_\_

Length: \_\_\_\_\_

# ADM/S-445

### Construction:

- 1 1/2" Round Tubing
- 2" x 3" Flanges
- Glass Brackets (accept 1/4" or 3/8")

### Available Finishes:

- Polished Stainless Steel
- Brushed Stainless Steel
- Powder Coated (Color Finishes)

### Glass:

- 3/8" Clear Tempered (Standard)
- 1/4" Clear Tempered (Optional)

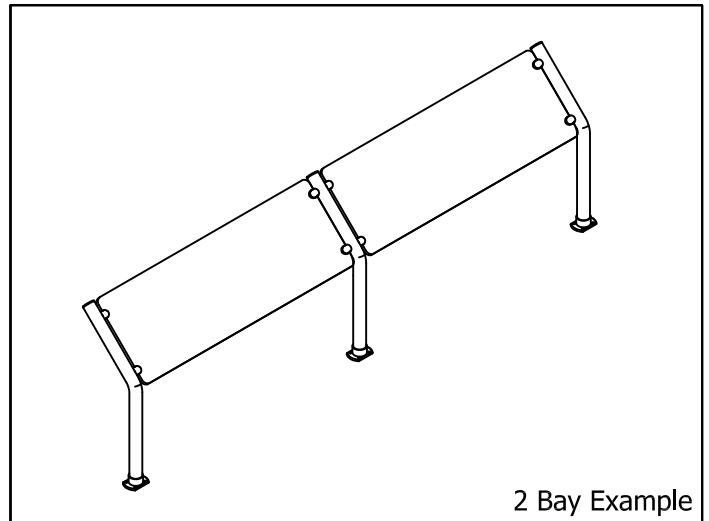
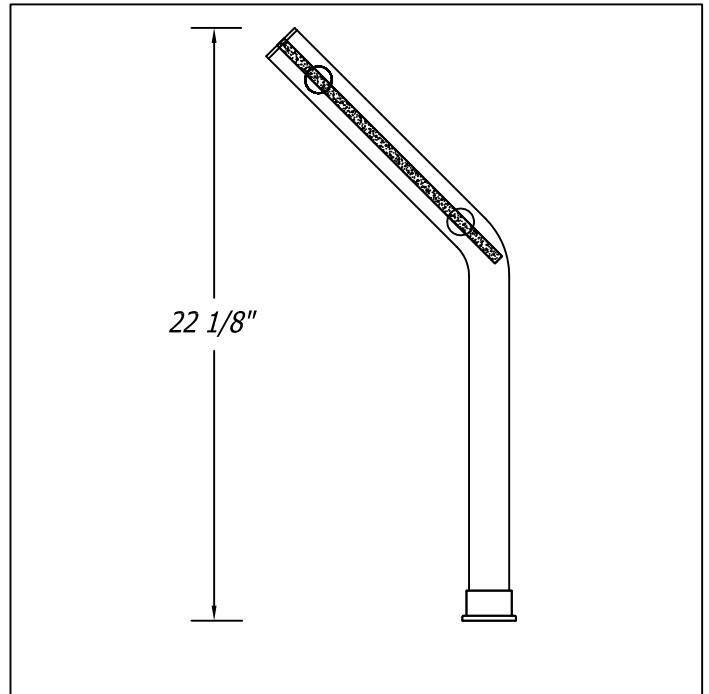

**NOTES:**

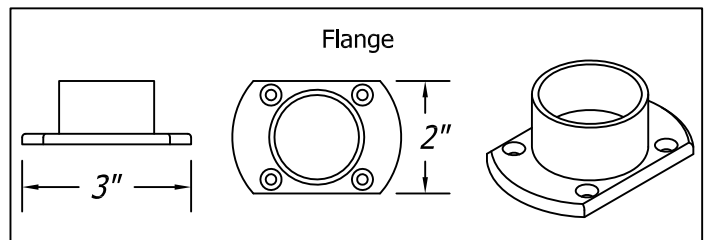

-E-MAIL-  
SALES@SNEEZEGUARDS.COM



-WEB SITE-  
WWW.SNEEZEGUARDS.COM