



Item:

SNEEZEGUARDS

Project Name: _____

Qty: _____

Length: _____

ADM/P-400

Construction:

- 1 1/2" Round Tubing
- 2" x 3" Flanges
- Glass Brackets (accept 1/4" or 3/8")

Available Finishes:

- Polished Stainless Steel
- Brushed Stainless Steel
- Powder Coated (Color Finishes)

Glass:

- 3/8" Clear Tempered (Standard)
- 1/4" Clear Tempered (Optional)

Options:

- Left Closed End Panel
- Right Closed End Panel
- Lighting
- Heat Lamps

NOTES:

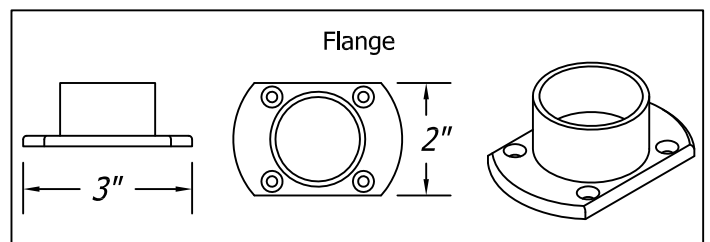
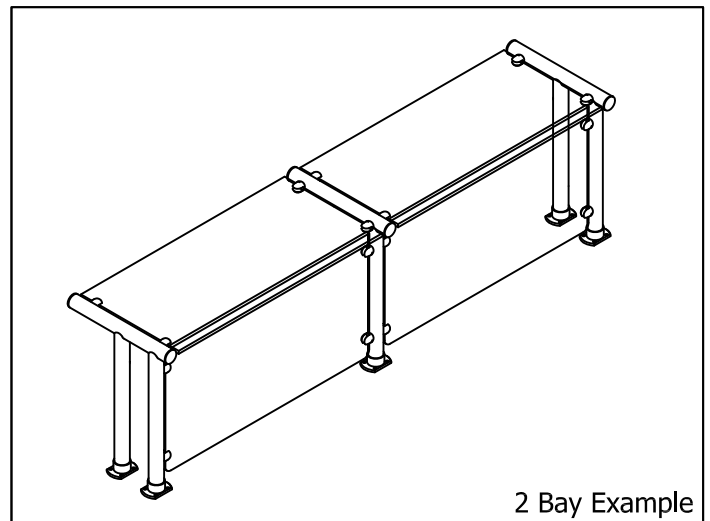
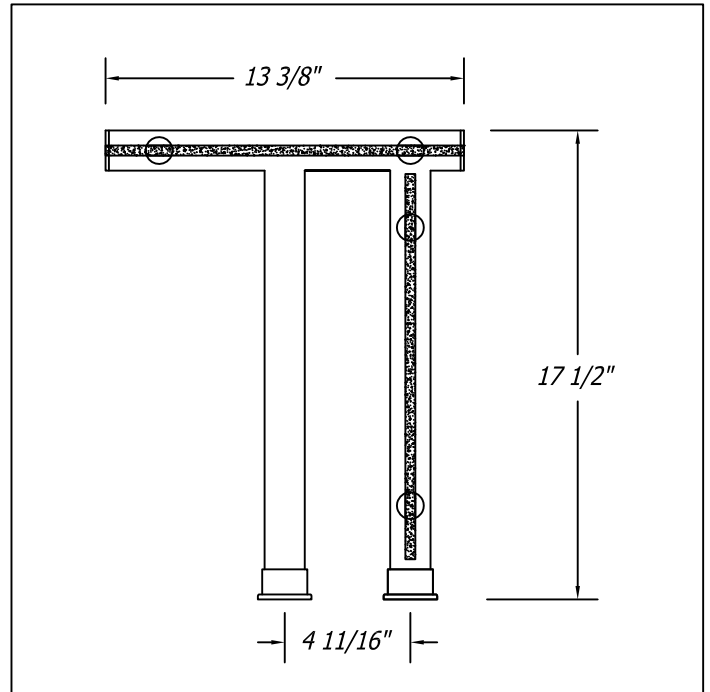

-E-MAIL-
SALES@SNEEZEGUARDS.COM



-WEB SITE-
WWW.SNEEZEGUARDS.COM